

IRG4PSH71KDPbF

INSULATED GATE BIPOLAR TRANSISTOR WITH
ULTRAFAST SOFT RECOVERY DIODE

Short Circuit Rated
UltraFast IGBT

Features

- Hole-less clip/pressure mount package compatible with TO-247 and TO-264, with reinforced pins
- High short circuit rating IGBTs, optimized for motorcontrol
- Minimum switching losses combined with low conduction losses
- Tightest parameter distribution
- IGBT co-packaged with ultrafast soft recovery antiparallel diode
- Creepage distance increased to 5.35mm
- Lead-Free

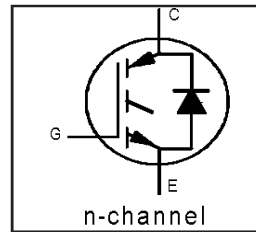

| |
|-----------------------------|
| $V_{CES} = 1200V$ |
| $V_{CE(on) typ.} = 2.97V$ |
| @ $V_{GE} = 15V, I_C = 42A$ |

Benefits

- Highest current rating copack IGBT
- Maximum power density, twice the power handling of the TO-247, less space than TO-264
- HEXFRED™ diode optimized for operation with IGBT, to minimize EMI, noise and switching losses

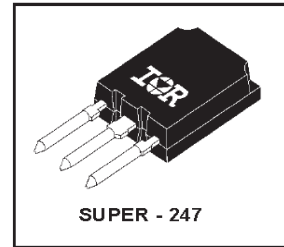

Absolute Maximum Ratings

| | Parameter | Max. | Units |
|---------------------------|------------------------------------|-----------------------------------|------------|
| V_{CES} | Collector-to-Emitter Voltage | 1200 | V |
| $I_C @ T_C = 25^\circ C$ | Continuous Collector Current | 78 | A |
| $I_C @ T_C = 100^\circ C$ | Continuous Collector Current | 42 | |
| I_{CM} | Pulsed Collector Current ① | 156 | |
| I_{LM} | Clamped Inductive Load Current ② | 156 | |
| $I_F @ T_C = 100^\circ C$ | Diode Continuous Forward Current | 42 | |
| I_{FM} | Diode Maximum Forward Current | 156 | |
| t_{sc} | Short Circuit Withstand Time | 10 | μs |
| V_{GE} | Gate-to-Emitter Voltage | ± 20 | V |
| $P_D @ T_C = 25^\circ C$ | Maximum Power Dissipation | 350 | W |
| $P_D @ T_C = 100^\circ C$ | Maximum Power Dissipation | 140 | |
| T_J | Operating Junction and | -55 to +150 | $^\circ C$ |
| T_{STG} | Storage Temperature Range | | |
| | Soldering Temperature, for 10 sec. | 300 (0.063 in. (1.6mm) from case) | |

Thermal Resistance\ Mechanical

| | Parameter | Min. | Typ. | Max. | Units |
|-----------------|---|-----------|----------|------|--------------|
| $R_{\theta JC}$ | Junction-to-Case - IGBT | --- | --- | 0.36 | $^\circ C/W$ |
| $R_{\theta JC}$ | Junction-to-Case - Diode | --- | --- | 0.69 | |
| $R_{\theta CS}$ | Case-to-Sink, flat, greased surface | --- | 0.24 | --- | |
| $R_{\theta JA}$ | Junction-to-Ambient, typical socket mount | --- | --- | 38 | |
| | Recommended Clip Force | 20.0(2.0) | --- | --- | N (kgf) |
| | Weight | --- | 6 (0.21) | --- | g (oz) |

Electrical Characteristics @ T_J = 25°C (unless otherwise specified)

| | Parameter | Min. | Typ. | Max. | Units | Conditions |
|--|---|------|------|------|-------|---|
| V _{(BR)CES} | Collector-to-Emitter Breakdown Voltage ^③ | 1200 | — | — | V | V _{GE} = 0V, I _C = 250μA |
| ΔV _{(BR)CES} /ΔT _J | Temperature Coeff. of Breakdown Voltage | — | 1.1 | — | V/°C | V _{GE} = 0V, I _C = 10mA |
| V _{CE(on)} | Collector-to-Emitter Saturation Voltage | — | 2.97 | 3.9 | V | I _C = 42A, V _{GE} = 15V |
| | | — | 3.44 | — | | I _C = 78A, V _{GE} = 15V |
| | | — | 2.60 | — | | I _C = 42A, T _J = 150°C |
| V _{GE(th)} | Gate Threshold Voltage | 3.0 | — | 6.0 | | V _{CE} = V _{GE} , I _C = 250μA |
| ΔV _{GE(th)} /ΔT _J | Temperature Coeff. of Threshold Voltage | — | -12 | — | mV/°C | V _{CE} = V _{GE} , I _C = 1.5mA |
| g _{fe} | Forward Transconductance ^④ | 25 | 38 | — | S | V _{CE} = 50V, I _C = 42A |
| I _{CES} | Zero Gate Voltage Collector Current | — | — | 500 | μA | V _{GE} = 0V, V _{CE} = 1200V |
| | | — | — | 10 | mA | V _{GE} = 0V, V _{CE} = 1200V, T _J = 150°C |
| V _{FM} | Diode Forward Voltage Drop | — | 2.5 | 3.7 | V | I _C = 42A, V _{GE} = 15V |
| | | — | 2.4 | — | | I _C = 42A, T _J = 150°C |
| I _{GES} | Gate-to-Emitter Leakage Current | — | — | ±100 | nA | V _{GE} = ±20V |

Switching Characteristics @ T_J = 25°C (unless otherwise specified)

| | Parameter | Min. | Typ. | Max. | Units | Conditions | |
|-------------------------|---|------|------|------|-------|--|--|
| Q _g | Total Gate Charge (turn-on) | — | 410 | 610 | nC | I _C = 42A | |
| Q _{ge} | Gate - Emitter Charge (turn-on) | — | 47 | 70 | | V _{CC} = 400V | |
| Q _{gc} | Gate - Collector Charge (turn-on) | — | 145 | 220 | | V _{GE} = 15V | |
| t _{d(on)} | Turn-On Delay Time | — | 67 | — | ns | T _J = 25°C | |
| t _r | Rise Time | — | 84 | — | | I _C = 42A, V _{CC} = 800V | |
| t _{d(off)} | Turn-Off Delay Time | — | 230 | 350 | | V _{GE} = 15V, R _G = 5.0Ω | |
| t _f | Fall Time | — | 130 | 190 | | Energy losses include "tail" and diode reverse recovery | |
| E _{on} | Turn-On Switching Loss | — | 5.68 | — | | See Fig. 9, 10, 18 | |
| E _{off} | Turn-Off Switching Loss | — | 3.23 | — | mJ | V _{CC} = 720V, T _J = 125°C | |
| E _{ts} | Total Switching Loss | — | 8.90 | 11.6 | | | V _{GE} = 15V, R _G = 5.0Ω |
| t _{sc} | Short Circuit Withstand Time | 10 | — | — | μs | V _{CC} = 720V, T _J = 125°C | |
| t _{d(on)} | Turn-On Delay Time | — | 65 | — | ns | T _J = 150°C, V _{CC} = 800V | |
| t _r | Rise Time | — | 87 | — | | I _C = 42A, V _{GE} = 15V, R _G = 5.0Ω | |
| t _{d(off)} | Turn-Off Delay Time | — | 370 | — | | Energy losses include "tail" and diode reverse recovery | |
| t _f | Fall Time | — | 290 | — | | mJ | Measured 5mm from package |
| E _{ts} | Total Switching Loss | — | 13.7 | — | | | |
| L _E | Internal Emitter Inductance | — | 13 | — | nH | | |
| C _{ies} | Input Capacitance | — | 5770 | — | pF | V _{GE} = 0V | |
| C _{oes} | Output Capacitance | — | 400 | — | | V _{CC} = 30V | |
| C _{res} | Reverse Transfer Capacitance | — | 100 | — | | f = 1.0MHz | |
| t _{rr} | Diode Reverse Recovery Time | — | 107 | 160 | ns | T _J = 25°C, I _F = 42A | |
| | | — | 160 | 240 | | T _J = 125°C, I _F = 42A | |
| I _{rr} | Diode Peak Reverse Recovery Current | — | 10 | 15 | A | T _J = 25°C, V _R = 200V | |
| | | — | 16 | 24 | | T _J = 125°C, V _R = 200V | |
| Q _{rr} | Diode Reverse Recovery Charge | — | 680 | 1020 | nC | T _J = 25°C, di/dt = 200A/μs | |
| | | — | 1400 | 2100 | | T _J = 125°C, di/dt = 200A/μs | |
| di _(rec) /dt | Diode Peak Rate of Fall of Recovery During t _b | — | 250 | — | A/μs | T _J = 25°C, See Fig. 17 | |
| | | — | 320 | — | | T _J = 125°C, See Fig. 17 | |

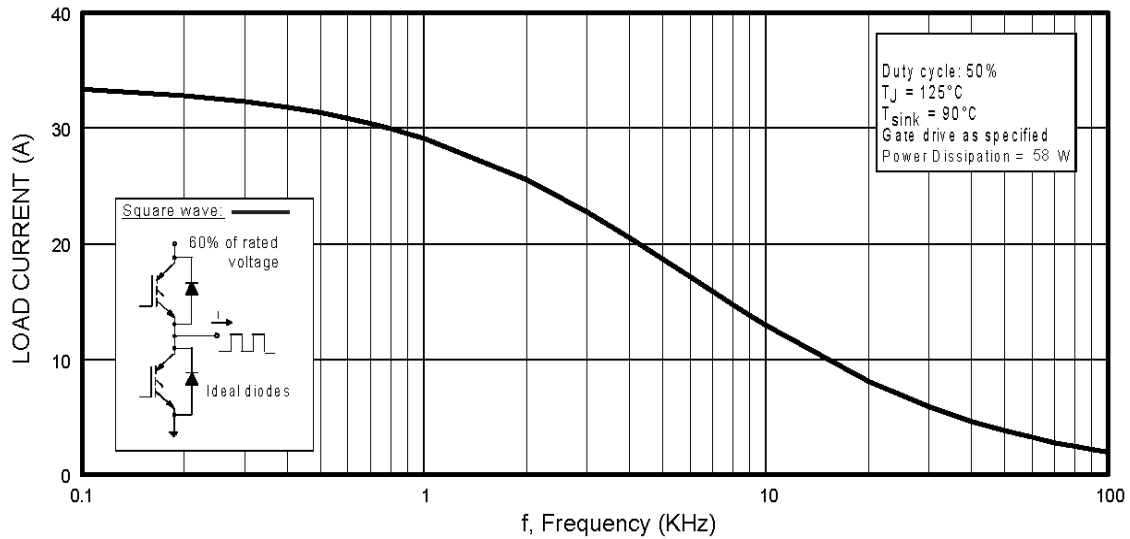

Fig. 1 - Typical Load Current vs. Frequency
 (Load Current = I_{RMS} of fundamental)

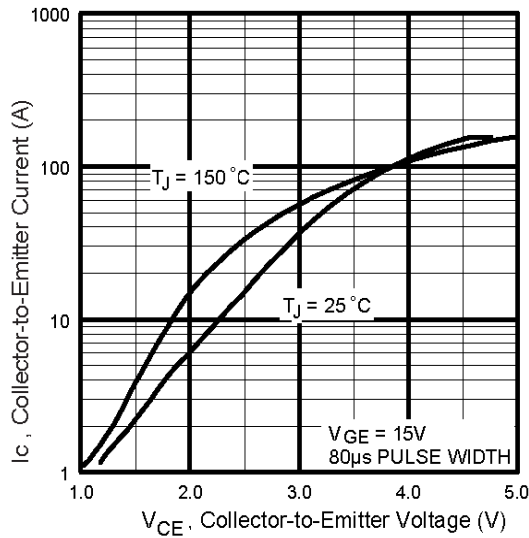

Fig. 2 - Typical Output Characteristics

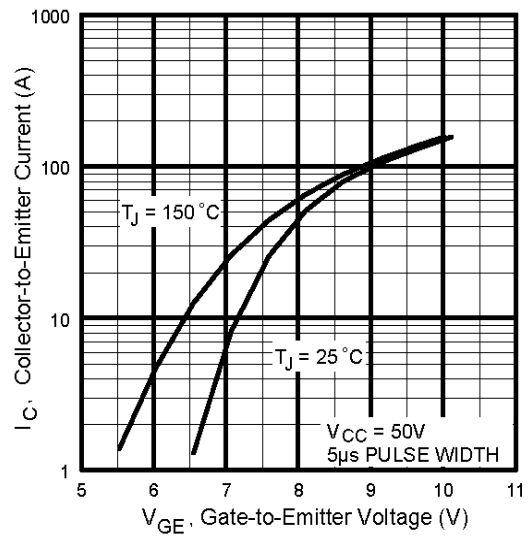

Fig. 3 - Typical Transfer Characteristics

IRG4PSH71KDPbF

International
IR Rectifier

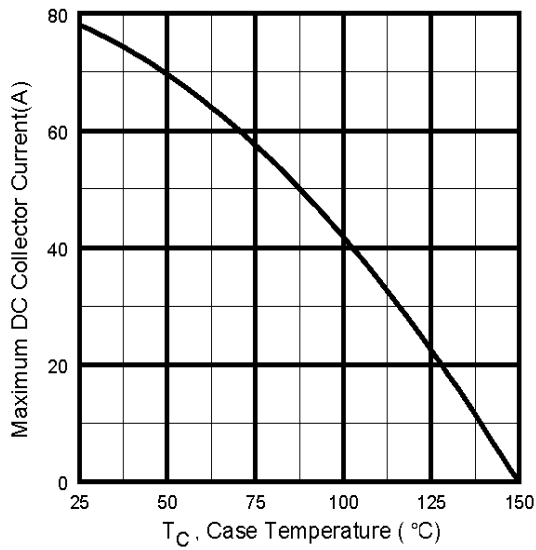

Fig. 4 - Maximum Collector Current vs. Case Temperature

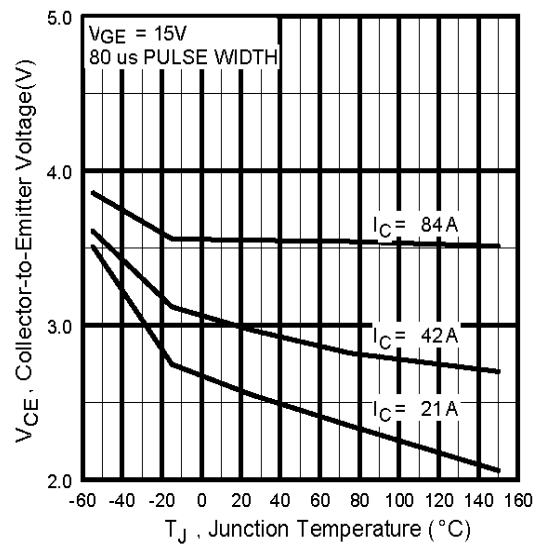

Fig. 5 - Typical Collector-to-Emitter Voltage vs. Junction Temperature

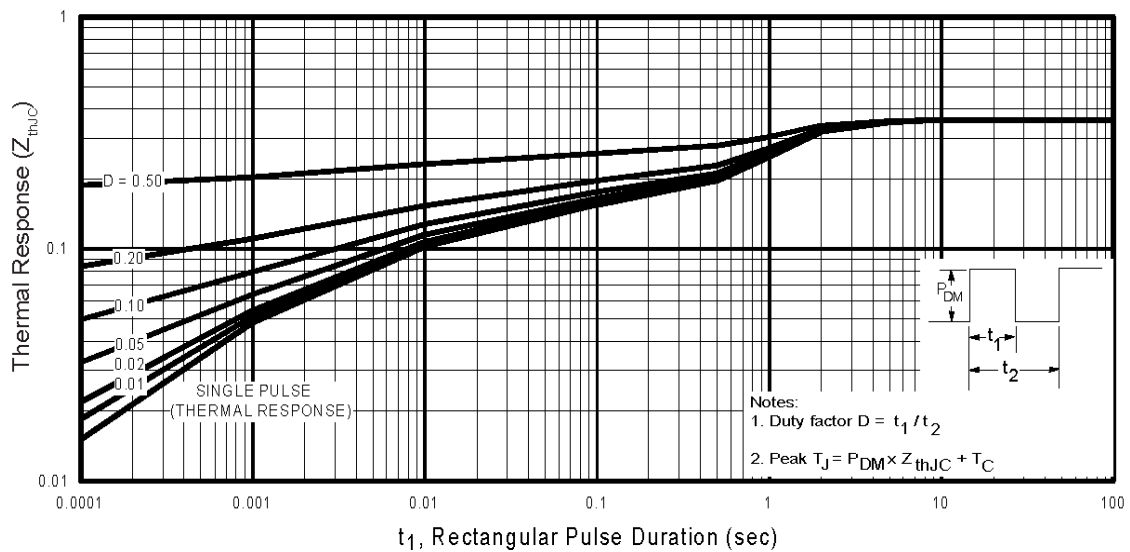

Fig. 6 - Maximum Effective Transient Thermal Impedance, Junction-to-Case

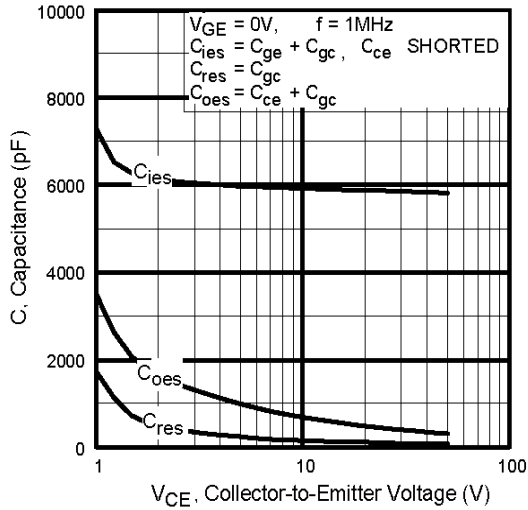

Fig. 7 - Typical Capacitance vs. Collector-to-Emitter Voltage

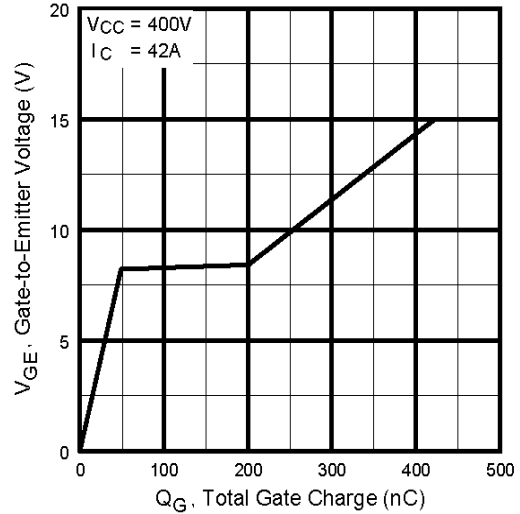

Fig. 8 - Typical Gate Charge vs. Gate-to-Emitter Voltage

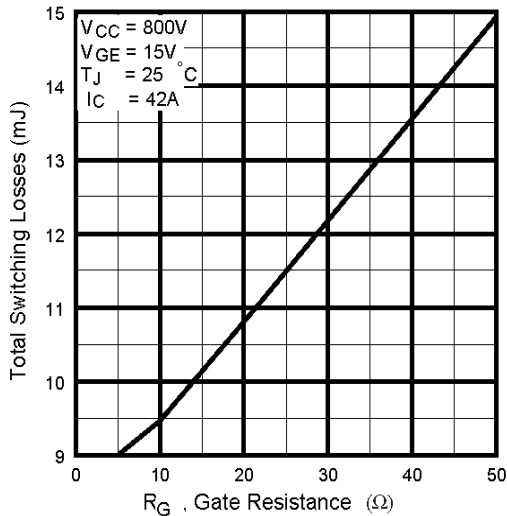

Fig. 9 - Typical Switching Losses vs. Gate Resistance

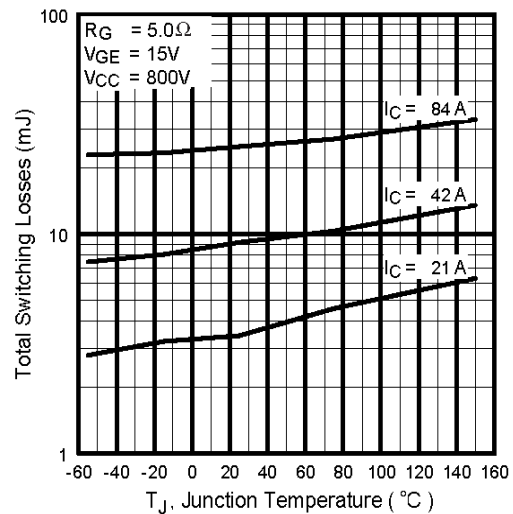
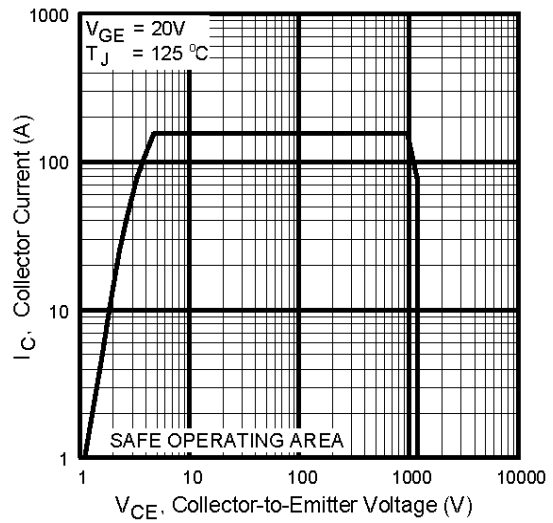
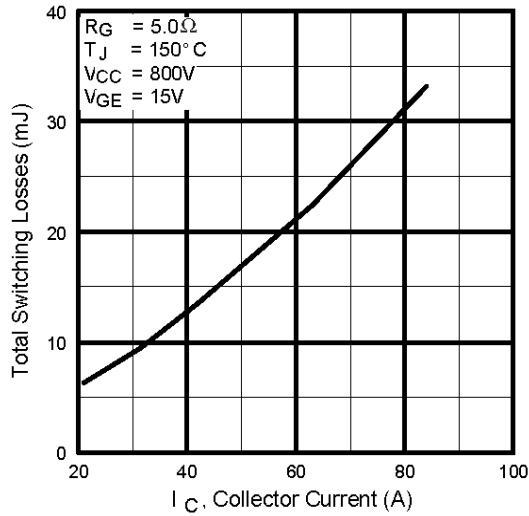

Fig. 10 - Typical Switching Losses vs. Junction Temperature

IRG4PSH71KDPbF

International
IR Rectifier



Collector-to-Emitter Current

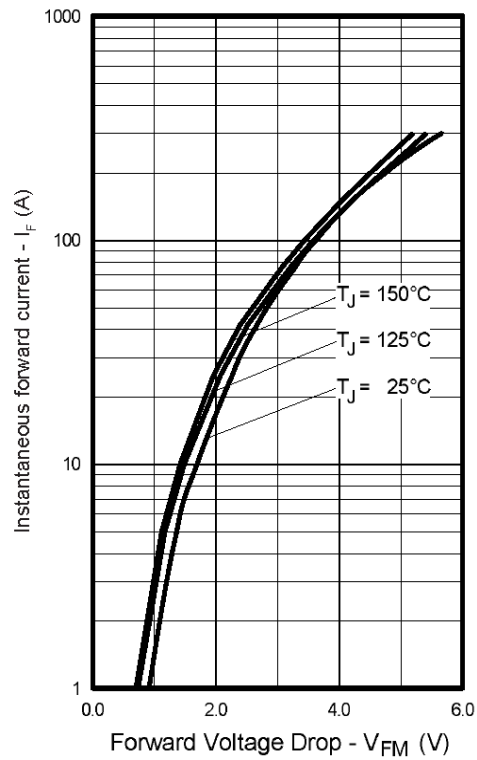

Fig. 13 - Maximum Forward Voltage Drop vs. Instantaneous Forward Current

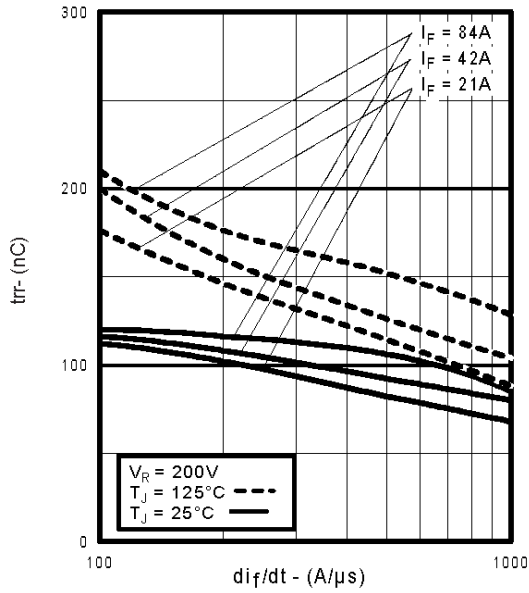

Fig. 14 - Typical Reverse Recovery vs. di_f/dt

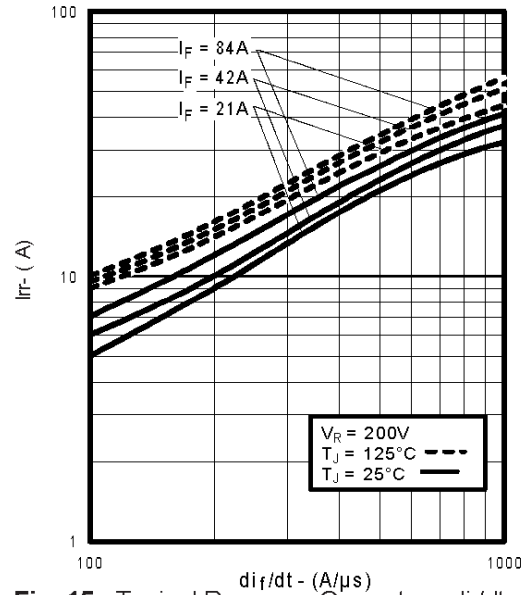

Fig. 15 - Typical Recovery Current vs. di_f/dt

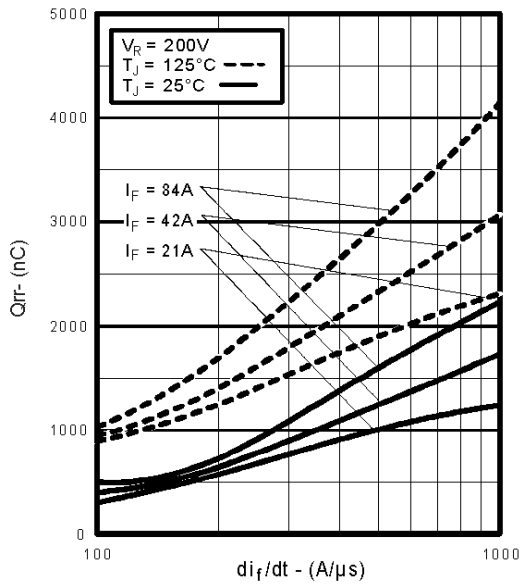

Fig. 16 - Typical Stored Charge vs. di_f/dt

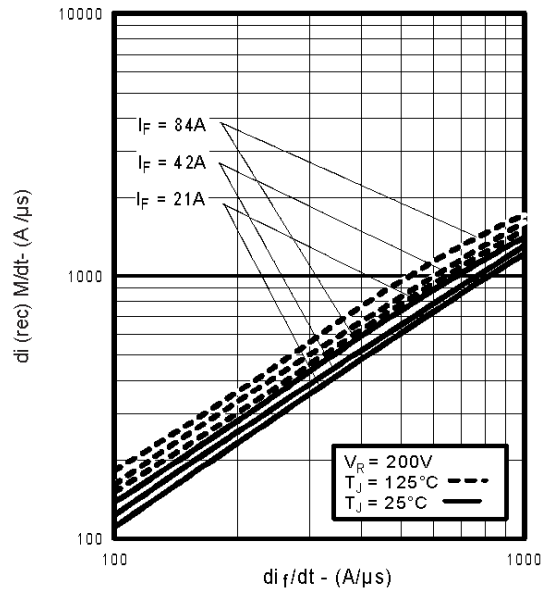

Fig. 17 - Typical $di_{(rec)M}/dt$ vs. di_f/dt

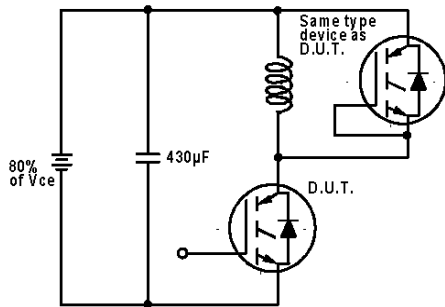

Fig. 18a - Test Circuit for Measurement of I_{LM} , E_{on} , $E_{off}(\text{diode})$, t_{rr} , Q_{rr} , I_{rr} , $t_{d(on)}$, t_r , $t_{d(off)}$, t_f

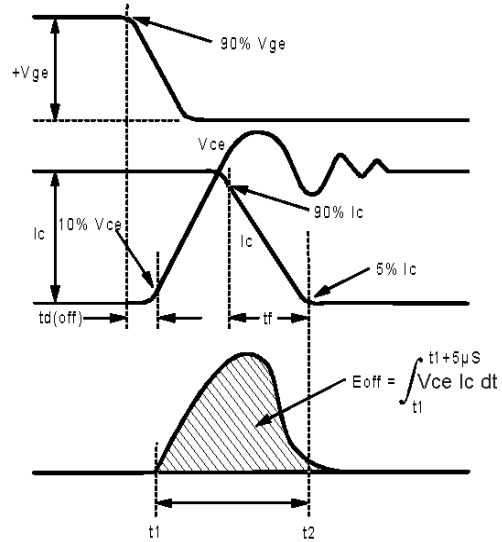

Fig. 18b - Test Waveforms for Circuit of Fig. 18a, Defining E_{off} , $t_{d(off)}$, t_f

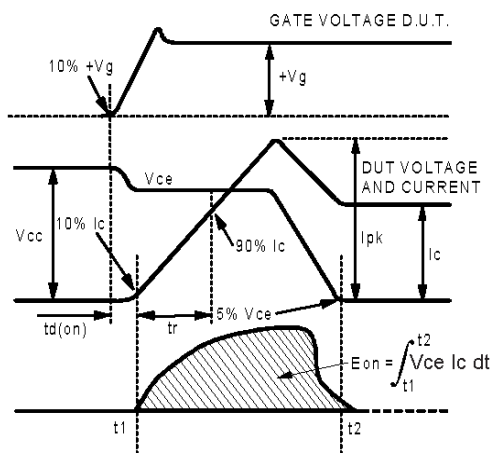

Fig. 18c - Test Waveforms for Circuit of Fig. 18a, Defining E_{on} , $t_{d(on)}$, t_r

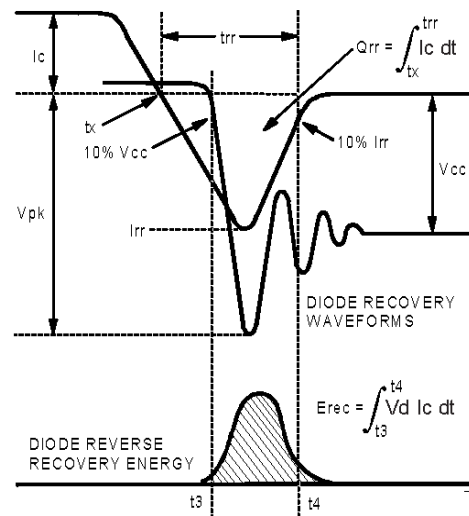

Fig. 18d - Test Waveforms for Circuit of Fig. 18a, Defining E_{rec} , t_{rr} , Q_{rr} , I_{rr}

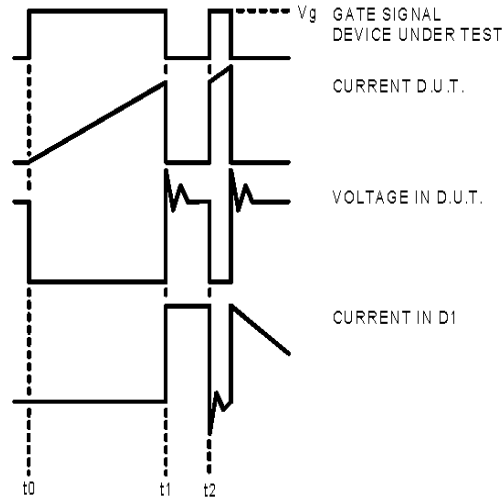

Figure 18e. Macro Waveforms for Figure 18a's Test Circuit

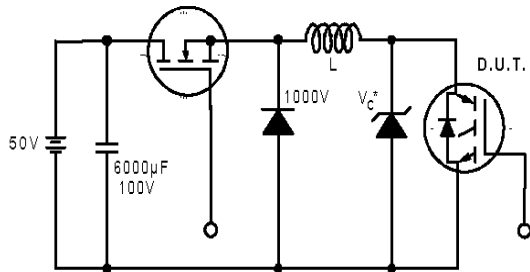

Figure 19. Clamped Inductive Load Test Circuit

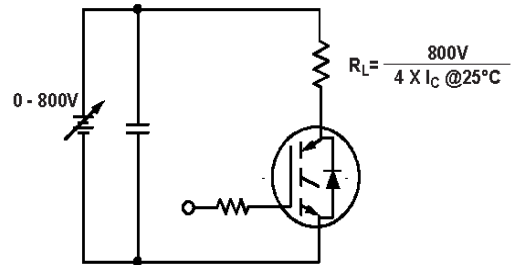
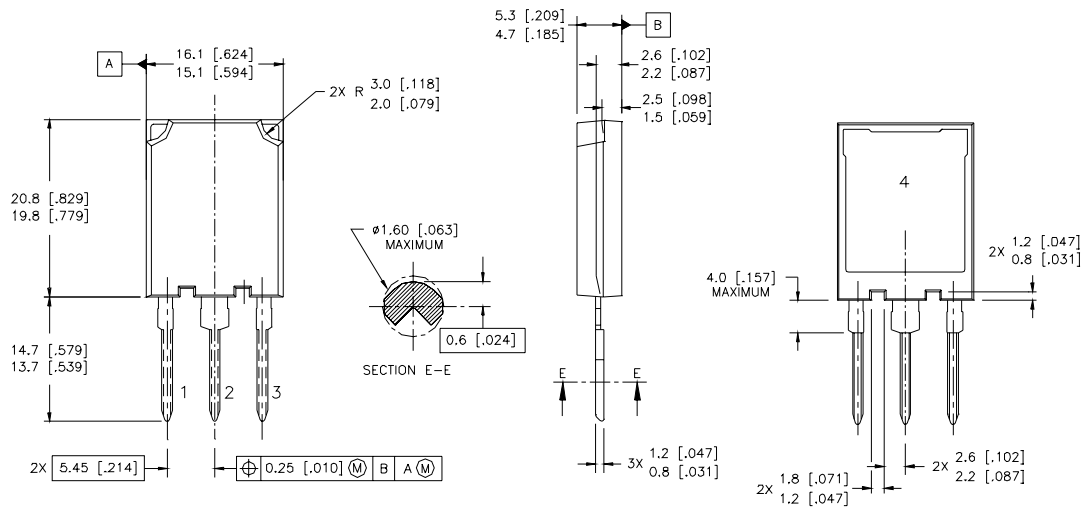

Figure 20. Pulsed Collector Current Test Circuit

IRG4PSH71KDPbF

International
IR Rectifier

Case Outline and Dimensions — Super-247



NOTES:

1. DIMENSIONS & TOLERANCING PER ASME Y14.5M-1994
2. CONTROLLING DIMENSION: MILLIMETER
3. DIMENSIONS ARE SHOWN IN MILLIMETRES [INCHES]

Notes:

- ① Repetitive rating: $V_{GE}=20V$; pulse width limited by maximum junction temperature (figure 20)
- ② $V_{CC}=80\%(V_{CES})$, $V_{GE}=20V$, $L=10\mu H$, $R_G=5.0\Omega$ (figure 19)
- ③ Pulse width $\leq 80\mu s$; duty factor $\leq 0.1\%$
- ④ Pulse width $5.0\mu s$, single shot

Super-247 (TO-274AA) Part Marking Information

EXAMPLE: THIS IS AN IRFPS37N50A WITH
ASSEMBLY LOT CODE 1789
ASSEMBLED ON WW 19, 1997
IN THE ASSEMBLY LINE "C"

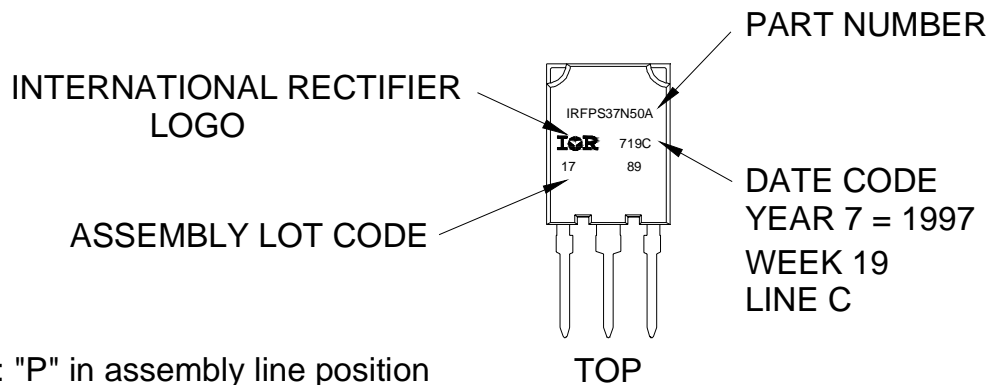

Note: "P" in assembly line position indicates "Lead-Free"

Data and specifications subject to change without notice.

International
IR Rectifier

IR WORLD HEADQUARTERS: 233 Kansas St., El Segundo, California 90245, USA Tel: (310) 252-7105
TAC Fax: (310) 252-7903

Visit us at www.irf.com for sales contact information. 09/04